

PCT

WORLD INTELLECTUAL PROPERTY ORGANIZATION
International Bureau



INTERNATIONAL APPLICATION PUBLISHED UNDER THE PATENT COOPERATION TREATY (PCT)

| | | |
|---|---|---|
| (51) International Patent Classification ⁷ : G06F 17/60 | A1 | (11) International Publication Number: WO 00/17800 |
| | | (43) International Publication Date: 30 March 2000 (30.03.00) |
| <p>(21) International Application Number: PCT/US99/22020</p> <p>(22) International Filing Date: 22 September 1999 (22.09.99)</p> <p>(30) Priority Data: 09/159,058 23 September 1998 (23.09.98) US</p> <p>(71) Applicant (for all designated States except US): HEALTH HERO NETWORK, INC. [US/US]; Suite 111, 2570 West El Camino Real, Mountain View, CA 94040 (US).</p> <p>(72) Inventor; and (75) Inventor/Applicant (for US only): BROWN, Stephen, J. [US/US]; 3324 Woodside Road, Woodside, CA 94062 (US).</p> <p>(74) Agent: GRAHAM, Lawrence D.; Black Lowe & Graham, PLLC, 816 Second Avenue, Seattle, WA 98104 (US).</p> | <p>(81) Designated States: AE, AL, AM, AT, AU, AZ, BA, BB, BG, BR, BY, CA, CH, CN, CU, CZ, DE, DK, EE, ES, FI, GB, GD, GE, GH, GM, HR, HU, ID, IL, IN, IS, JP, KE, KG, KP, KR, KZ, LC, LK, LR, LS, LT, LU, LV, MD, MG, MK, MN, MW, MX, NO, NZ, PL, PT, RO, RU, SD, SE, SG, SI, SK, SL, TJ, TM, TR, TT, UA, UG, US, UZ, VN, YU, ZA, ZW, ARIPO patent (GH, GM, KE, LS, MW, SD, SL, SZ, TZ, UG, ZW), Eurasian patent (AM, AZ, BY, KG, KZ, MD, RU, TJ, TM), European patent (AT, BE, CH, CY, DE, DK, ES, FI, FR, GB, GR, IE, IT, LU, MC, NL, PT, SE), OAPI patent (BF, BJ, CF, CG, CI, CM, GA, GN, GW, ML, MR, NE, SN, TD, TG).</p> <p>Published <i>With international search report. Before the expiration of the time limit for amending the claims and to be republished in the event of the receipt of amendments.</i></p> | |

(54) Title: REDUCING RISK USING BEHAVIORAL AND FINANCIAL REWARDS

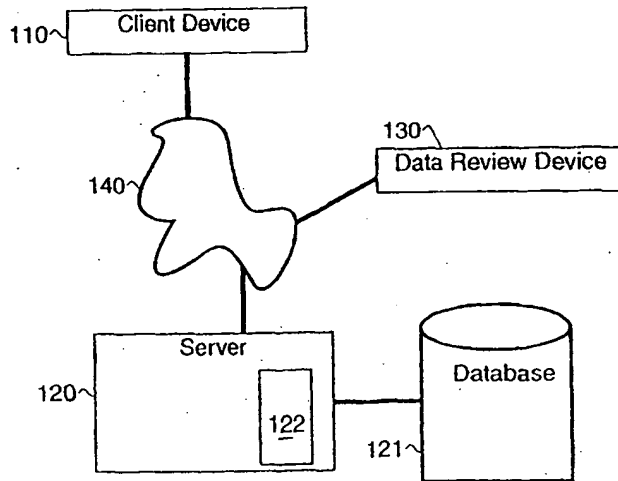

(57) Abstract

The invention provides a set of techniques and products in which one or more insured persons and one or more associated beneficiaries are monitored with regard to dynamic risk reassessment, given feedback information in response to that dynamic risk reassessment, and are encouraged to comply with the feedback. The insured persons and associated beneficiaries are coupled to a client-server system disposed for dynamic measurement of medical information, and the client-server system is disposed for alerting the insured persons and associated beneficiaries to suggested behaviors for reducing risk. The invention includes an insurance product in which portions of the insurance premium are allocated to one or more components, in response to compliance with the suggested behaviors.

FOR THE PURPOSES OF INFORMATION ONLY

Codes used to identify States party to the PCT on the front pages of pamphlets publishing international applications under the PCT.

| | | | | | | | |
|----|--------------------------|----|--|----|--|----|--------------------------|
| AL | Albania | ES | Spain | LS | Lesotho | SI | Slovenia |
| AM | Armenia | FI | Finland | LT | Lithuania | SK | Slovakia |
| AT | Austria | FR | France | LU | Luxembourg | SN | Senegal |
| AU | Australia | GA | Gabon | LV | Latvia | SZ | Swaziland |
| AZ | Azerbaijan | GB | United Kingdom | MC | Monaco | TD | Chad |
| BA | Bosnia and Herzegovina | GE | Georgia | MD | Republic of Moldova | TG | Togo |
| BB | Barbados | GH | Ghana | MG | Madagascar | TJ | Tajikistan |
| BE | Belgium | GN | Guinea | MK | The former Yugoslav Republic of Macedonia | TM | Turkmenistan |
| BF | Burkina Faso | GR | Greece | | | TR | Turkey |
| BG | Bulgaria | HU | Hungary | ML | Mali | TT | Trinidad and Tobago |
| BJ | Benin | IE | Ireland | MN | Mongolia | UA | Ukraine |
| BR | Brazil | IL | Israel | MR | Mauritania | UG | Uganda |
| BY | Belarus | IS | Iceland | MW | Malawi | US | United States of America |
| CA | Canada | IT | Italy | MX | Mexico | UZ | Uzbekistan |
| CF | Central African Republic | JP | Japan | NE | Niger | VN | Viet Nam |
| CG | Congo | KE | Kenya | NL | Netherlands | YU | Yugoslavia |
| CH | Switzerland | KG | Kyrgyzstan | NO | Norway | ZW | Zimbabwe |
| CI | Côte d'Ivoire | KP | Democratic People's Republic of Korea | NZ | New Zealand | | |
| CM | Cameroon | | | PL | Poland | | |
| CN | China | KR | Republic of Korea | PT | Portugal | | |
| CU | Cuba | KZ | Kazakstan | RO | Romania | | |
| CZ | Czech Republic | LC | Saint Lucia | RU | Russian Federation | | |
| DE | Germany | LJ | Liechtenstein | SD | Sudan | | |
| DK | Denmark | LK | Sri Lanka | SE | Sweden | | |
| EE | Estonia | LR | Liberia | SG | Singapore | | |

WO 00/17800

PCT/US99/22020

**APPLICATION FOR UNITED STATES LETTERS PATENT FOR:
REDUCING RISK USING BEHAVIORAL AND FINANCIAL REWARDS**

1 These known methods increase the incentive for the insured entity to re-
2 duce the insured-against risk. However, these methods are subject to several draw-
3 backs. Where the insured-against risk is relatively inevitable (such as with life
4 insurance or long-term care insurance), the insurance company finds it difficult to
5 avoid the inevitability of a claim. Rather, it is in the underwriter's interest to stave off
6 the claim for as long as possible.

7 Certain kinds of insurance (such as long-term care insurance) also have a
8 substantial effect on the family of the insured person. For example, the insured person
9 is often faced with the dilemma of either (1) reduction to penury to qualify for gov-
10 ernment support, or (2) spending their entire estate on long-term care. The family of
11 the insured person also has interests against these options.

12 Accordingly, it would be advantageous to provide a method and system
13 to increase the incentive for the insured entity to reduce the insured-against risk, even
14 when that insured-against risk is relatively inevitable. In the case of long-term care
15 insurance, it is in the underwriter's interest to provide incentives for the insured person
16 and their family to maintain the insured person's health and independence for as long
17 as possible (quite apart from the emotional incentives they already have).

18 Application Serial No. _____, Express Mail Mailing No. EE 261 914
19 722 US, filed September 23, 1998, in the name of Stephen J. Brown, titled "Dynamic

1 Modeling and Scoring Risk Assessment,” assigned to the same assignee, attorney
2 docket number HHN-003 describes techniques for modeling and scoring risk assess-
3 ment that are time-dependent, and in one embodiment are responsive to progression of
4 a disease or degenerative condition in a patient.

5 One aspect of this co-pending application is that the insurer can dynami-
6 cally adjust the risk assessment of individual insured persons in response to actions
7 taken (or not taken) by those insured persons to maintain their own health. The un-
8 derwriter can thus dynamically adjust the cost or the benefits of the insurance policy in
9 response to those actions. By doing so, the underwriter, the insured person, and the
10 insured person’s family have the common goal of maximizing the useful life and inde-
11 pendence of the insured person.

12 As described in the co-pending application, dynamic reassessment can
13 be performed in conjunction with a monitoring and scoring system for determining
14 risk assessment for populations and for individuals with regard to those populations.

15 It would also be desirable for the insured person (and associated others)
16 to make use of dynamic risk reassessment to monitor and influence the behavior of the
17 insured person, to reduce the risk. It would also be desirable to provide the insured
18 person, and the insured person’s family with information available to the underwriter,

1 and to suggest particular prescribed or proscribed actions that would reduce short-term
2 risk and provide a greater payoff for all concerned.

3 Accordingly, it would be advantageous to provide the insured person,
4 and associated others, with feedback information from dynamic reassessment of the
5 risk associated with the insured person, so that the insured person, and associated oth-
6 ers, can act to minimize that risk. This advantage is achieved in an embodiment of the
7 invention in which the insured person and their beneficiaries are provided with feed-
8 back information and instruction responsive to dynamic risk reassessment, and in
9 which payments from an associated set of insurance products are allocated dependant
10 on compliance with that feedback. For example, one such insurance product includes
11 a long-term care component and a life insurance component, and devotes a fraction of
12 the product premium to one or the other component in response to compliance with the
13 feedback offered by the underwriter.

14 Summary of the Invention

15 The invention provides a set of techniques and products in which one or
16 more insured persons and one or more associated beneficiaries are monitored with re-
17 gard to dynamic risk reassessment, are given feedback information responsive to that
18 dynamic risk reassessment, and are encouraged to comply with the feedback informa-
19 tion. In a preferred embodiment, the insured persons and associated beneficiaries are

1 coupled to a client-server system that is configured to obtain dynamic measurement of
2 medical information (for example, using bio-medical devices or using a question and
3 answer format), and the client-server system is configured to alert the insured persons
4 and associated beneficiaries to suggested behaviors for reducing risk. The preferred
5 embodiment includes an insurance product in which portions of the insurance pre-
6 mium are allocated to one or more components (such as a long-term care benefit or a
7 life insurance benefit), in response to compliance with the suggested behaviors. Thus,
8 the insured is provided with an incentive for compliance with the suggested behaviors
9 for reducing risk by receiving a more beneficial allocation of the premium to the com-
10 ponents of the insurance product.

11 In a preferred embodiment, an insured patient is examined at intervals by
12 medical personnel, to determine medical information that can be used as factors for
13 dynamically determining a risk assessment for that insured patient. The medical per-
14 sonnel can determine a medical regimen (possibly including diet, exercise, prescribed
15 medication, or other factors) that are intended to reduce the insured-against risk. The
16 insured patient, and where appropriate, associated beneficiaries or other close rela-
17 tions, use a client device with a client-server system to provide dynamic medical in-
18 formation regarding the condition of the insured. For example, the client device can
19 periodically measure blood glucose, blood pressure, heart rate, weight, and the like.
20 Similarly, the client device can periodically question the insured patient or the close

1 relations for information about the insured, such as affect or mentation, diet or exer-
2 cise, and the like.

3 In response to the prescribed medical regimen and information from the
4 insured patient, a server device receiving that information from the client device can
5 dynamically reassess risk factors associated with that insured patient, and can alert
6 medical personnel or close relations in response thereto. In response to dynamic risk
7 assessment, the server device can modify which portions of an insurance premium (or
8 other financial product payments) are allocated to one or more components (such as a
9 long-term care component or a life insurance component). The server device can use
10 patient compliance with the suggested medical regimen as one measure to be factored
11 into the dynamic risk assessment.

12

Description of the Drawings

- 13 Fig. 1A shows a block diagram of a system for data collection and inter-
14 pretation for a population;
- 15 Fig. 1B shows details of the client device shown in Fig. 1A.
- 16 Fig. 1C shows devices that may be connected to client device;
- 17 Fig. 1D shows details of the data review device;

- 1 Fig. 2 illustrates a data flow diagram indicating some of the data paths
2 used in a preferred embodiment;
- 3 Fig. 3A illustrates a process for determining dynamic risk assessment;
- 4 Fig. 3B illustrates a process used to evaluate patient information;
- 5 Fig. 4 illustrates a process used to respond to risk; and
- 6 Fig. 5 illustrates a process used to determine feedback information.

7 Description of the Preferred Embodiments

8 In the following description, a preferred embodiment of the invention is
9 described with regard to preferred process steps and data structures. Embodiments of
10 the invention can be implemented using general-purpose processors or special purpose
11 processors operating under program control, or other circuits, adapted to particular
12 process steps and data structures described herein. Other embodiments include com-
13 puter program products that contain computer code embodied in a computer readable
14 media for causing a computer to perform the process steps. Implementation of the
15 process steps and data structures described herein would not require undue experi-
16 mentation or further invention.

1 ***Related Applications***

2 Inventions described herein can be used in combination or conjunction
3 with inventions described in the following patent applications. These patent applica-
4 tions are hereby incorporated by reference as if fully set forth herein:

- 5 • Application Serial No. 09/041,809, filed November 21, 1997 in the
6 name of Stephen J. Brown, titled "Phenoscope and Phenobase," as-
7 signed to the same assignee, attorney docket number RYA-136;
- 8 • Application Serial No. _____, filed _____, in the name of Ste-
9 phen J. Brown, titled "Health Management Process Control System,"
10 assigned to the same assignee, attorney docket number RYA-114.
- 11 • Application Serial No. _____, filed _____, in the name of Ste-
12 phen J. Brown and Erik K. Jensen, titled "On-line Health Education
13 and Feedback System Using Motivational Driver Profile Coding and
14 Automated Content Fulfillment," assigned to the same assignee, at-
15 torney docket number RYA-115.
- 16 • Application Serial No. _____, filed _____, in the name of Ste-
17 phen J. Brown, titled "Multiple Patient Monitoring System for Pro-
18 active Health Management," assigned to the same assignee, attorney
19 docket number RYA-116.

- 1 • Application Serial No. _____, filed _____, in the name of Ste-
- 2 phen J. Brown, titled "On-Line Health Education Using Composites
- 3 of Entertainment and Personalized Health Information," assigned to
- 4 the same assignee, attorney docket number RYA-119a.
- 5 • Application Serial No. _____, filed _____, in the name of Ste-
- 6 phen J. Brown, titled "Monitoring System for Remotely Querying In-
- 7 dividuals," assigned to the same assignee, attorney docket number
- 8 RYA-126.
- 9 • Application Serial No. _____, filed _____, in the name of Ste-
- 10 phen J. Brown, titled "Multi-User Remote Health Monitoring Sys-
- 11 tem," assigned to the same assignee, attorney docket number RYA-
- 12 131a.
- 13 • Application Serial No. _____, Express Mail Mailing No. EE 261
- 14 914 722 US, filed September 23, 1998, in the name of Stephen J.
- 15 Brown, titled "Dynamic Modeling and Scoring Risk Assessment,"
- 16 assigned to the same assignee, attorney docket number HHN-003.
- 17

1 ***System for Reducing Risk***

2 The invention enables dynamic risk determination of an insured's condi-
3 tion. An example of when the invention can be used is if the insured has a progressive
4 condition, which will eventually require long-term care (such as diabetes), but for
5 which in-home care is currently appropriate. Another example where dynamic risk
6 determination can be used is if the insured is at risk for a medical setback (such as an
7 MI or a stroke) but currently is capable of self-care. Yet another example is when the
8 insured is currently being cared for by family, but the care burden is increasing and the
9 insured will eventually require long-term care. The invention allows the underwriter
10 to dynamically determine the current risk to the insured and to provide incentives to
11 the insured to reduce that risk.

12 Fig. 1A shows a block diagram of a system for data collection and inter-
13 pretation for a population.

14 Referring to Fig. 1A, a system 100 includes a client device 110, a server
15 device 120 including a database of information 121 and a program memory 122, and a
16 data review element 130. These devices are connected via a communication channel
17 140, such as a communication network as is well known in the art, and as more fully
18 described in the Phenoscope and Phenobase patent application (serial no. 09/041,809).

1 - The communication channel 140 may be a simple point-to-point network
2 (for example a wire connecting the client device 110 with the server device 120), or a
3 complex network such as the Internet.

4 Referring to Fig. 1B, the client device 110 is disposed locally to a patient
5 111 (the insured), and includes an output element 112 for presenting information to the
6 patient 111, and an input element 113 for entering information from the patient 111.
7 As used herein, "locally" refers to a logical relationship to the patient 111, and does
8 not have any necessary implication with regard to actual physical position. In a pre-
9 ferred embodiment, the client device 110 is relatively small or compact, and can be
10 disposed on a night table or otherwise near the patient 111.

11 The output element 112 includes a display screen 114, on which ques-
12 tions and suggested answers can be displayed for the patient 111, to facilitate informa-
13 tion entry, or on which instructions can be displayed for the patient 111, to instruct the
14 patient 111. The output element 112 can also include a speaker 115, to present infor-
15 mation in conjunction with or in alternative to the display screen 114. The output ele-
16 ment 112 can also include a bell or other sound element, or a bright light 119 or a flag,
17 to alert the patient 111 that the client device 110 has questions or information for the
18 patient 111.

1 The input element 113 includes a plurality of buttons 116A-D for enter-
2 ing information.

3 The input element 113 can also include one or more data ports 117A-D
4 for entering information from other devices. Referring to Fig. 1C, such other devices
5 118 can include a medical measurement device, such as a blood glucose meter or a
6 blood pressure monitor. Such other devices 118 can also include a general purpose or
7 special purpose client workstation, such as a personal computer or a hand-held digital
8 calendar.

9 The server device 120 is disposed logically remotely from the patient
10 111, and includes a database 121 of information about the patient 111 and about other
11 patients in a related population thereof. As used herein, "remotely" refers to a logical
12 relationship to the patient 111, and does not have any necessary implication with re-
13 gard to actual physical position.

14 The database 121 includes medical history, medical regimen, and risk
15 progression information for the insured and a similarly situated population. The data-
16 base 121 also includes the compliance background for the insured indicating how well
17 the insured follows the prescribed medical regimen and avoids the proscribed activi-
18 ties.

1 The server device 120 also includes the program memory 122 that con-
2 tains program code and data to cause the server device 120 to perform subsequently
3 described processes.

4 In a preferred embodiment, the server 120 and database 121 are prefera-
5 bly accessible using a standard network connection (such as a world wide web con-
6 nection). The server 120 and database 121 may include single stand-alone computers
7 or multiple computers distributed throughout a network.

8 The data review element 130 is disposed logically remotely from the pa-
9 tient 111, and includes an interface 131 disposed for use by an operator 132. The op-
10 erator 132 can comprise medical personnel, a device operated by medical personnel, or
11 a similar device, capable of interacting with the interface 131 to receive information
12 from the data review element 130 and possibly to enter information into the data re-
13 view element 130. Information entered into the data review element 130 can be en-
14 tered for ultimate transmission to the server device 120 or to the client device 110.

15 The data review element 130 is preferably a personal computer, remote
16 terminal, web TV unit, Palm Pilot unit, interactive voice response system, or any other
17 communication technique. The data review element 130 functions as a remote inter-
18 face for entering server 120 or client device 110 messages and queries to be communi-
19 cated to the individuals. The data review element 130 also functions to provide the

1 professional to evaluate the progression of the insured and to monitor the insured's
2 medical regimen.

3 Other and further information regarding the system 100 is shown in Ap-
4 plication Serial No. 09/041/809, titled "Phenoscope and Phenobase," attorney docket
5 number RYA-136 and Application Serial No. _____, titled "Dynamic Modeling
6 and Scoring Risk Assessment," attorney docket number HHN-003.

7 Fig. 2 illustrates a data flow diagram, indicated by general reference
8 character 200, that indicates how data flows within a preferred embodiment. The
9 nodes include an insured 201, a client device 203, a server device 205, an accounting
10 server 207, a work station 209, and a professional 211. These nodes are connected by
11 data flows that include an 'insured-client device' data stream 221, an client device-
12 insured data stream 223, a client-server data stream 225, a server-client data stream
13 227, a server-workstation data stream 229, a workstation-server data stream 231, a
14 workstation-professional data stream 233, a professional-workstation data stream 235,
15 a 'workstation-accounting server' data stream 237, an 'accounting server-insured' data
16 stream 239, and an 'accounting server-server device' data stream 241. Each of these
17 data streams transfer data between the nodes connected by the data stream.

18 In particular the server device sends patient protocol and interrogatories
19 to the insured by sending this information across the server-client data stream 227 to

1 the client device 203. The client device 203 then instructs or queries the insured 201
2 utilizing the client device-insured data stream 223. The insured 201 responds to the
3 queries, instructions, or through bio-medical input devices to the client device 203 us-
4 ing the 'insured-client device' data stream 221. The client device 203 passes this ac-
5 quired information to the server device 205 over the client-server data stream 225.
6 The server device 205 stores the information acquired from the insured 201.

7 Feedback is provided to the insured 201 by sending feedback informa-
8 tion from the server device 205 to the client device 203. This feedback information
9 can include additional medical regimens for the insured 201 to timely follow (for ex-
10 ample, additional tests that are determined by the server device 205 responsive to the
11 information just gathered from the insured).

12 The professional 211 uses the work station 209 (passing data over both
13 the workstation-professional data stream 233 and the professional-workstation data
14 stream 235) to access and/or modify data received by, stored on or created on the
15 server device 205. This data is accessed using the server-workstation data stream 229.
16 The professional 211 can also modify the medical regimen for the insured or provide
17 other information for the insured. These modifications are sent to the server device
18 205 over the workstation-server data stream 231 and then to the insured using the
19 server-client data stream 227, the client device 203, and the client device-insured data
20 stream 223. The professional 211, using the work station 209 can send information

1 (reflecting benefits to the insured) to the accounting server 207 using the 'workstation-
2 accounting server' data stream 237. The status of benefits can be sent directly to the
3 insured using the 'accounting server-insured' data stream 239 (for example by using
4 postal mail, FAX or other traditional mechanism) or the information can be sent over
5 the 'accounting server-server device' data stream 241 to the server device 205 and on
6 to the insured using previously discussed paths.

7 The professional 211 assesses the insured-against risk using both the
8 static data most recently collected from the insured, the progression over time of the
9 data collected from the insured and information known to, or accessible by the profes-
10 sional 211. This assessment includes the insured's compliance with the prescribed
11 medical regimens and other environmental and behavioral factors. This assessment
12 can also include information and recommendations provided by artificial intelligence
13 expert systems that are accessible to the professional 211 through the work station 209.

14 Fig. 3A illustrates a dynamic risk assessment process, indicated by gen-
15 eral reference character 300, for determining dynamic risk assessment. The dynamic
16 risk assessment process 300 is cyclic in normal circumstances. A 'gather patient in-
17 formation' step 301 obtains medical information (such as bio-medical information)
18 from the insured (using the client device 110) by using a series of questions or by us-
19 ing bio-medical sensors. The medical information is gathered according to a protocol
20 provided by the server device 120. This medical information is sent to a server device

1 that performs an 'evaluate patient information' step 303 that determines one or more
2 risk factors for the insured as is subsequently described with respect to Fig. 3B. Next,
3 the dynamic risk assessment process 300 delays for an appropriate time at a delay step
4 305. This delay can be varied as appropriate for the insured, the insured's condition,
5 the caregivers, and the insurance provider. The delay step 305 determines the time
6 interval between gathering information from the insured and is appropriately set to be
7 (for example and without limitation) some number of days, weeks or months. Eventu-
8 ally, the delay ends at an 'delay complete' step 307 and the dynamic risk assessment
9 process 300 repeats at the 'gather patient information' step 301 to re-determine the in-
10 sured-against risk for the insured.

11 The medical information gathered by the 'gather patient information'
12 step 301 is specific to the insured's current risk and progression of the condition. For
13 example, the insured or caregiver may be periodically instructed to check for sores on
14 extremities if the insured is diabetic. In addition, the caregiver can provide informa-
15 tion about affect or mentation. If the insured interacts with the client device 110, the
16 response time to questions can also be gathered.

17 The 'gather patient information' step 301 and the 'evaluate patient in-
18 formation' step 303 can be repeated dependent on the data acquired from the insured
19 by the previous iteration. Thus, if the previous iteration returned data that indicates
20 that a subsequent test should be performed, the server device 120 can send the client

1 device 110 a protocol to cause the client device 110 to obtain the new information
2 from the insured, caregiver, or other person.

3 Fig. 3B illustrates an 'evaluate patient information' process, indicated by
4 general reference character 320 that reassesses the risk based on the gathered informa-
5 tion and responds to that risk. The 'evaluate patient information' process 320 is in-
6 voked by the 'evaluate patient information' step 303 of Fig. 3A and initiates at a 'start'
7 terminal 321. The 'evaluate patient information' process 320 continues to a 'send data
8 to server device' procedure 323, performed by the client device 110, that sends the
9 medical information gathered by the client device 110 to the server device 120. The
10 medical information is stored on the database 121 by a 'store data' procedure 325.

11 Once the medical information is stored, a 'reassess risk' procedure 327
12 (as disclosed in Application Serial No. _____, attorney docket number HHN-003)
13 can use the medical information, a risk-assessment model and the database 121 to de-
14 termine the current risk of the insured. The risk includes one or more risk factors.
15 These risk factors are used to determine an insured-against risk.

16 Example risk factors include information such as "patient smokes," "pa-
17 tient has diabetes," "patient has diabetes and doesn't bother to check his blood sugar
18 regularly," etc.

1 Once the insured-against risk has been determined, the 'evaluate patient
2 information' process 320 continues to a 'respond to risk' procedure 329 (subsequently
3 described with respect to Fig. 4). The 'respond to risk' procedure 329 determines one
4 or more medical regimens for the insured. These medical regimens are selected to re-
5 duce the risk factors and thus to reduce the insured-against risk of the insured. The
6 'respond to risk' procedure 329 can also adjust the proportion of the insurance cost
7 allocated to components of the financial product used by the insured. The 'reassess
8 risk' procedure 327 and the 'respond to risk' procedure 329 need not be performed
9 every time data is received by the server device 120. These procedures can be exe-
10 cuted independent of the following procedures.

11 Once the medical information is stored by the 'store data' procedure 325
12 the dynamic risk assessment process 300, can also continue to a 'determine feedback
13 information' procedure 331 that develops feedback for the insured that can include one
14 or more medical regimens, display of bio-medical information, encouragement to fol-
15 low the suggested medical regimen or follow-on protocols. The feedback information
16 is sent back to the client device 110 by a 'send feedback information' procedure 333.
17 A 'present feedback information' procedure 335 then presents the feedback informa-
18 tion to the insured and/or the caregiver. The 'evaluate patient information' process
19 320 completes through an 'end' terminal 337.

1 The 'determine feedback information' procedure 331 can also provide
2 the client device 110 with additional data gathering protocols that are dependent on the
3 just-gathered information — to obtain additional information. In addition, the 'deter-
4 mine feedback information' procedure 331 checks to determine whether the just-
5 gathered information is out-of-limit, indicates a trend, or should be forwarded to a
6 medical professional.

7 Other preferred embodiments can allocate these processes between the
8 client device 110 and the server device 120 in a different manner. For example as the
9 relative cost/performance ratio changes for the client device 110 and the server device
10 120, more of these procedures can be moved to the client device 110.

11 Fig. 4 illustrates a 'respond to risk' process, indicated by general refer-
12 ence character 400, that is configured to adjust the cost of the financial product be-
13 tween the components of the financial product for the insured. The 'respond to risk'
14 process 400 is invoked by the 'respond to risk' procedure 329 and initiates at a 'start'
15 terminal 401. The 'respond to risk' process 400 then continues to a 'risk change' deci-
16 sion procedure 403 that determines whether the current insured-against risk has suffi-
17 ciently changed from the existing insured-against risk retrieved from the database 121.
18 If the insured-against risk has not sufficiently changed, the 'respond to risk' process
19 400 completes through an 'end' terminal 405. Otherwise, the 'respond to risk' process
20 400 continues to an 'allocate benefits' procedure 407 that reallocates the cost to the

1 insured between the components of the financial product to correspond to the new in-
2 sured-against risk. Where the insured-against risk is reduced, the new allocation re-
3 wards the insured. However, if the insured-against risk has increased, the insured is
4 penalized. Next, an 'inform' procedure 409 generates information that will be pro-
5 vided to the insured and/or the caregiver either using postal mail or as information
6 provided to the insured by the 'present feedback information' procedure 335. This
7 procedure also provides the new allocations to an accounting database and/or the pay-
8 out system for the financial product. Next, the 'respond to risk' process 400 completes
9 through the 'end' terminal 405.

10 In a financial product that has at least two components (such as a long-
11 term care component and a life insurance component) the 'allocate benefits' procedure
12 407 determines a cost for the long term care component and allocates a first payment
13 to that component of the financial product. The 'allocate benefits' procedure 407 then
14 allocates a second payment to the life insurance component of the financial product, to
15 an annuity, or to another benefit for the insured (such as a refund). The second pay-
16 ment is a function of the first payment. This payment allocation is structured to pro-
17 vide an incentive to the insured to conform to the currently suggested medical
18 regimen.

19 Fig. 5 illustrates a 'determine feedback information' process, indicated
20 by general reference character 500, used to assemble the feedback information. The

1 'determine feedback information' process 500 is invoked by the 'determine feedback
2 information' procedure 331 and initiates at a 'start' terminal 501. A 'correlate regimen
3 with risk factors' procedure 503 uses the risk factors determined by the 'reassess risk'
4 procedure 327 to select one or more medical regimens that can be provided to the in-
5 sured. An 'evaluate regimen history' procedure 505 then uses the history of medical
6 regimens suggested to the insured and stored on the database 121 to determine the pre-
7 ferred selection of medical regimens. Then a 'modify regimen' procedure 507 modi-
8 fies the existing medical regimen if the existing medical regimen is different from the
9 preferred medical regimen. The 'modify regimen' procedure 507 may change the data
10 collection protocol used by the client device 110. These procedures 503, 505, and 507
11 are all dynamic in that they use historical information collected from the insured and
12 are responsive to the progressive nature of the information collected about the insured.
13 This is particularly important for those having a progressive condition or degenerative
14 disease (for example, diabetes, and CHD).

15 Next, a 'select feedback language' procedure 509 selects the language
16 used to present the feedback information to the insured. Often, the selected language
17 is a natural language such as English. However, the 'select feedback language' proce-
18 dure 509 can also control how much technical jargon is to be included. Thus, the lan-
19 guage can be customized for the educational and experience level of the insured and/or
20 the caregiver. A 'prepare feedback information' procedure 511 assembles the feed-

1 back information including the suggested medical regimens coded for the language of
2 the insured. The 'determine feedback information' process 500 completes through an
3 'end' terminal 513.

4 The 'correlate regimen with risk factors' procedure 503 evaluates the
5 risk factors, the insured's progression and the information gathered from the insured to
6 identify medical regimens best suited to gather additional information from the insured
7 or to help the insured to reduce the insured-against risk. One embodiment of the in-
8 vention uses Bayesian statistical techniques to perform this correlation.

9 ***Alternative Embodiments***

10 Although preferred embodiments are disclosed herein, many variations
11 are possible which remain within the concept, scope, and spirit of the invention, and
12 these variations would become clear to those skilled in the art after perusal of this ap-
13 plication.

Claims

What is claimed is:

- 1 1. A method including steps of:
 - 2 dynamically determining an insured-against risk associated with an in-
 - 3 sured;
 - 4 providing feedback information to said insured responsive to said in-
 - 5 sured-against risk; and
 - 6 providing an incentive to said insured to reduce said insured-against risk.

- 1 2. The computer controlled method of claim 1 wherein the step of providing an
2 incentive further includes steps of:
3 dynamically determining a cost for a first component of a financial prod-
4 uct responsive to said insured-against risk;
5 allocating a first payment to said first component in response to said
6 cost; and
7 allocating a second payment, responsive to said first payment, to a sec-
8 ond component of said financial product;
9 whereby said first component and second component have different values to
10 said insured.
- 1 3. The computer controlled method of claim 1 wherein the step of dynamically
2 determining further includes steps of:
3 determining one or more risk factors associated with said insured at a
4 plurality of times; and
5 re-determining said insured-against risk associated with said insured re-
6 sponsive to the step of determining one or more risk factors.

- 1 4. The computer controlled method of claim 3 wherein the step of determining
2 one or more risk factors further includes steps of:
- 3 gathering, at a client device, medical information for said insured at said
4 plurality of times;
- 5 sending said medical information from said client device to a server de-
6 vice remote from said insured; and
- 7 comparing, at said server device, said medical information with a risk-
8 assessment model.
- 1 5. The computer controlled method of claim 3 wherein the step of providing
2 feedback information further includes steps of:
- 3 associating, at said server device, a medical regimen with at least one of
4 said one or more risk factors;
- 5 sending said medical regimen from said server device to said client de-
6 vice; and
- 7 presenting said medical regimen at said client device.

- 1 6. An apparatus including:
- 2 a client-server system having a client device and having a server device that
- 3 is logically remote from an insured;
- 4 wherein said client device is configured for collecting medical information
- 5 regarding said insured and for sending said medical information to said
- 6 server device;
- 7 wherein said server device is configured to dynamically assess a risk value
- 8 associated with said insured in response to said medical information, and to
- 9 allocate an incentive responsive to said risk value;
- 10 whereby said incentive is responsive to said medical information regarding
- 11 said insured.

- 1 7. A financial product including:
- 2 a first component having a cost responsive to a dynamic assessment of
- 3 risk associated with an insured, said first component having a first benefit as-
- 4 sociated with said insured; and
- 5 a second component having a second benefit associated with said in-
- 6 sured, said second benefit responsive to said cost;
- 7 whereby changes in said dynamic assessment of risk determine a relative al-
- 8 location of said first benefit and said second benefit.
- 1 8. The financial product of claim 7 wherein the first component includes a long-
- 2 term care policy having a long-term care benefit.
- 1 9. The financial product of claim 7 wherein the second component includes a
- 2 life insurance policy having a life insurance benefit.

- 1 10. A method including:
- 2 providing a financial product that includes a first component and a sec-
- 3 ond component, said first component having a cost responsive to a dynamic
- 4 assessment of risk associated with an insured, said first component having a
- 5 first benefit associated with said insured, said second component having a
- 6 second benefit associated with said insured, said second benefit responsive to
- 7 said cost;
- 8 obtaining medical information about said insured;
- 9 determining said dynamic assessment of risk using said information; and
- 10 changing said first benefit and said second benefit responsive to said dy-
- 11 namic assessment of risk.
- 1 11. The method of claim 10 wherein the first component includes a long-term
- 2 care policy having a long-term care benefit.
- 1 12. The method of claim 10 wherein the second component includes a life insur-
- 2 ance policy having a life insurance benefit.

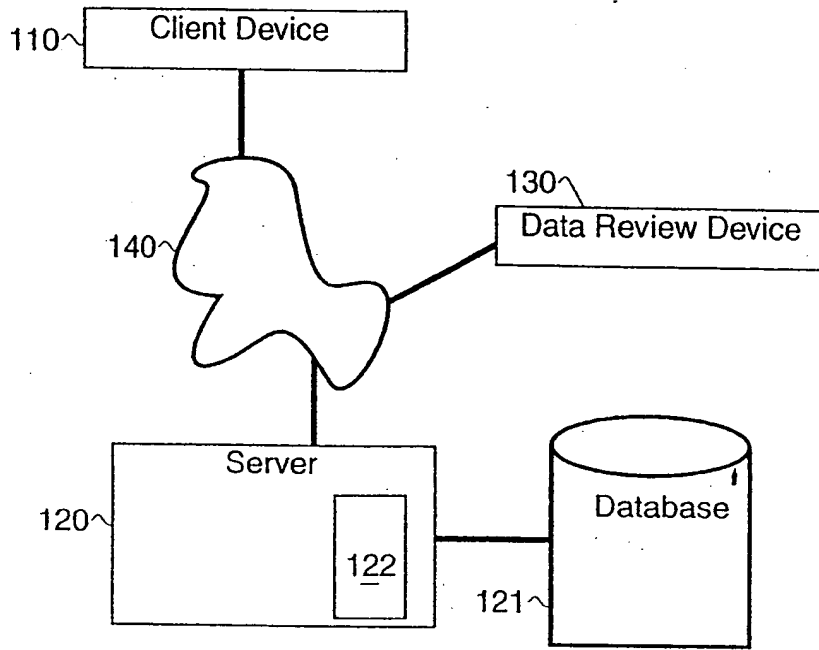
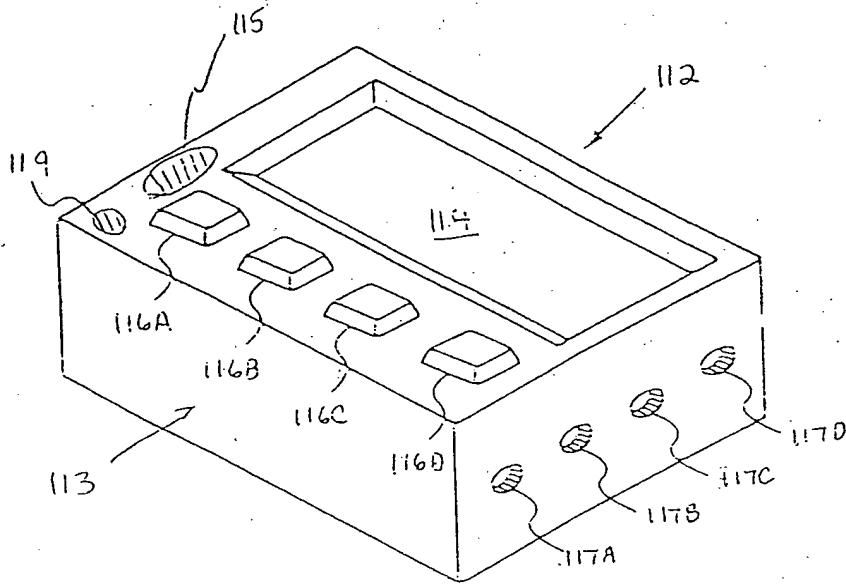

Fig. 1A



110

FIG. 1b

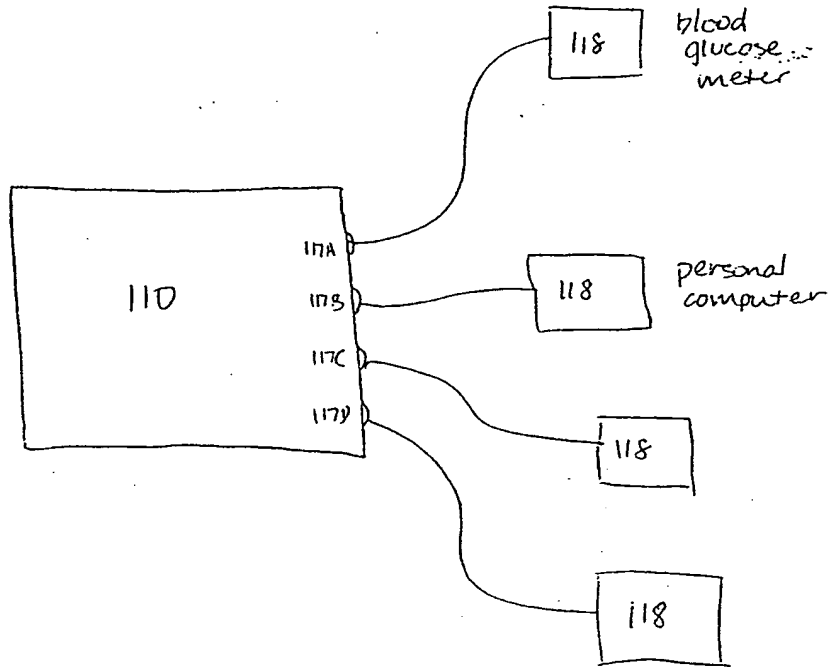

Figure 1c

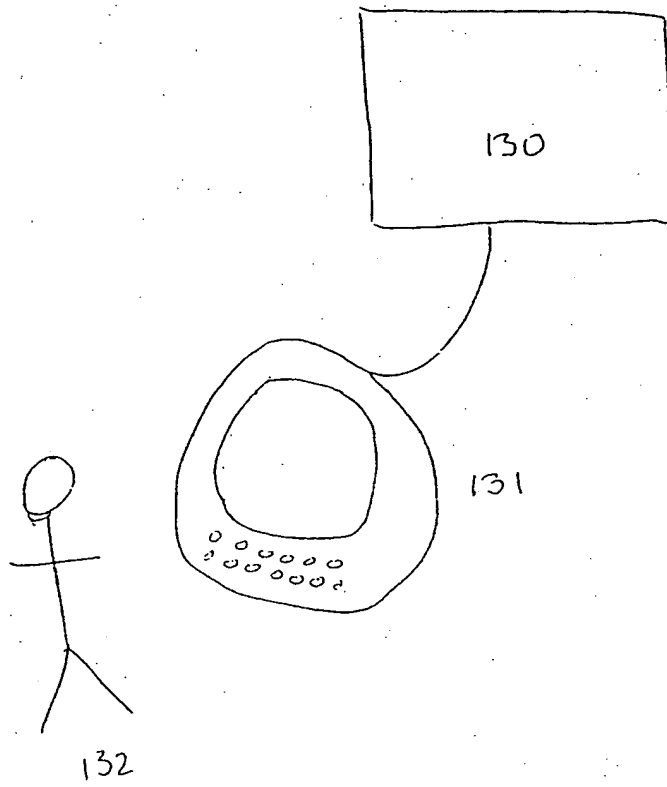

Figure 1d

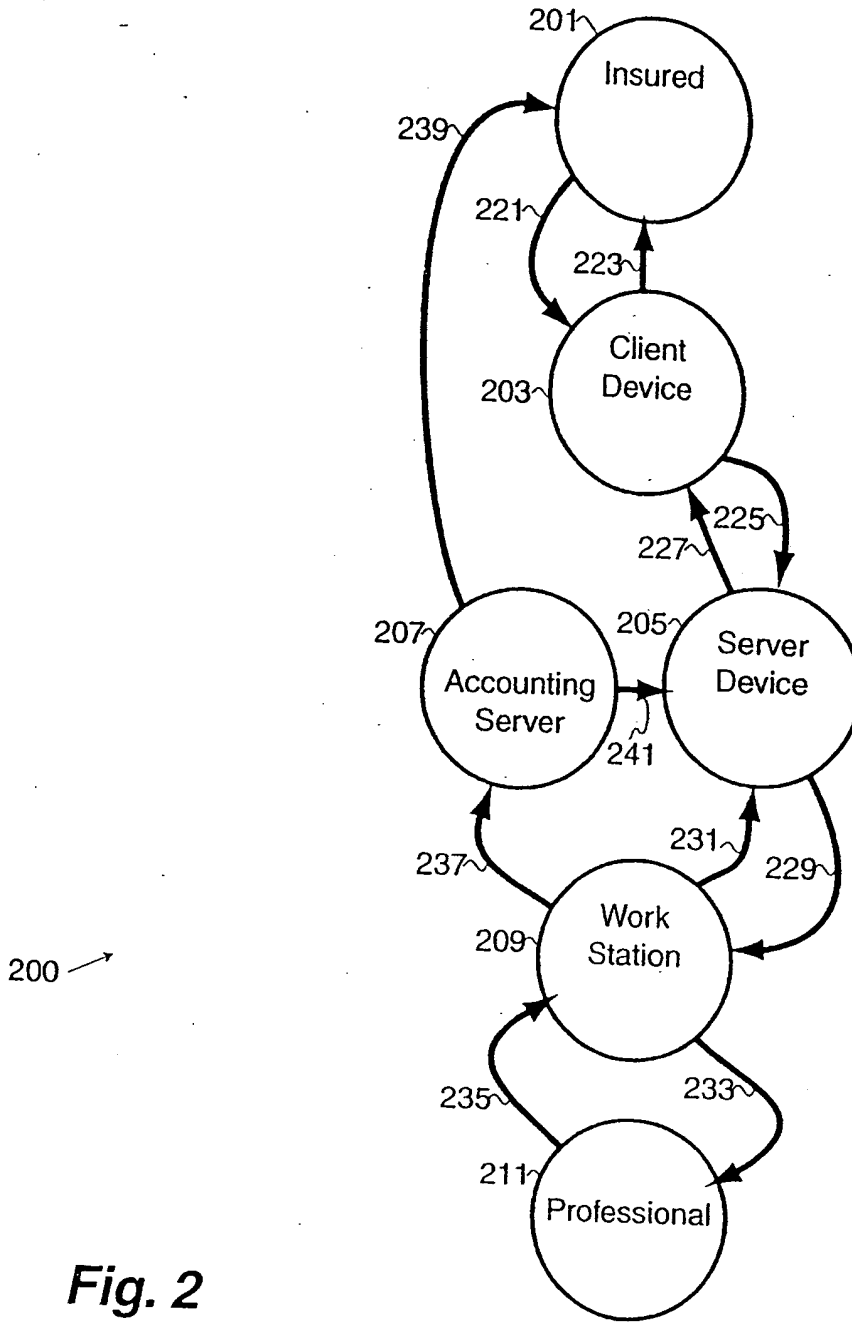
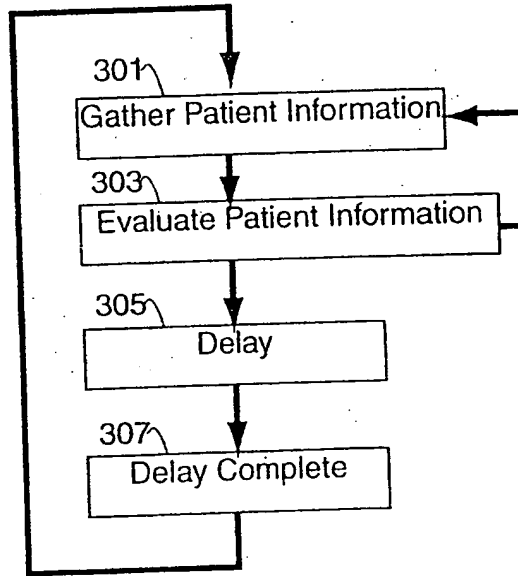

Fig. 2



300 →
Fig. 3A

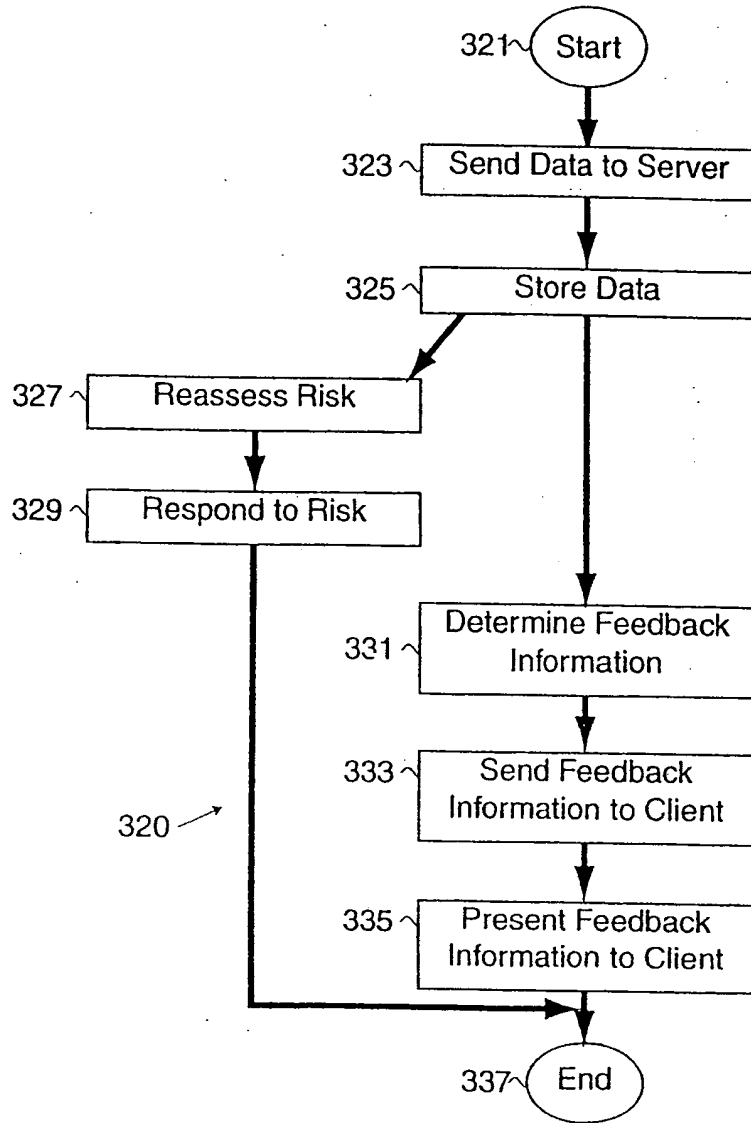

Fig. 3B

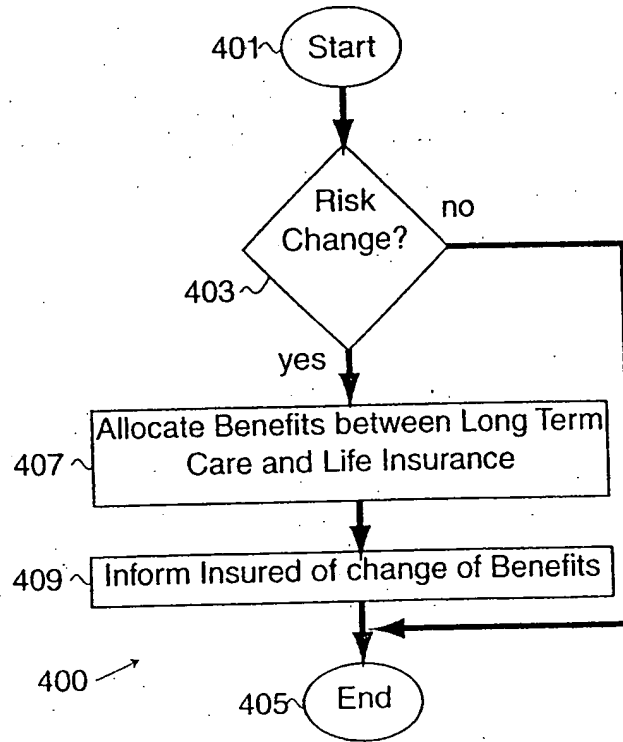

Fig. 4

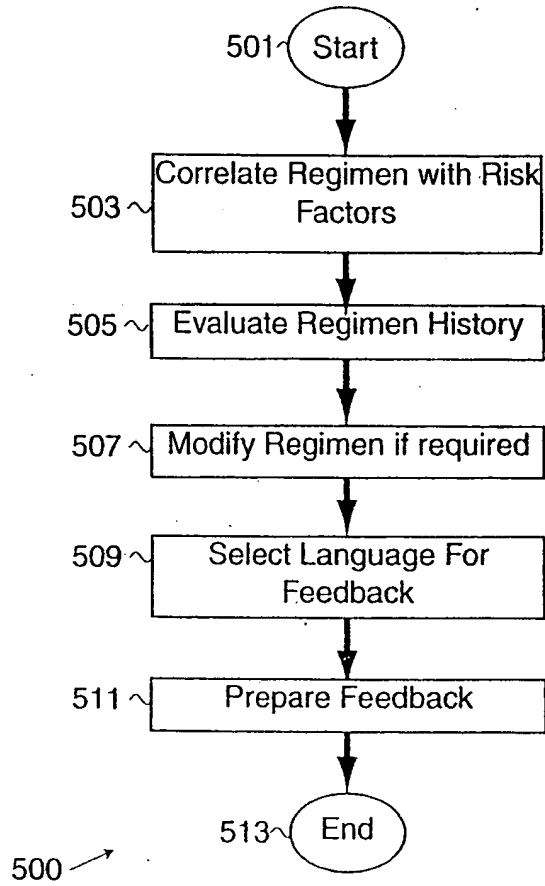

Fig. 5

INTERNATIONAL SEARCH REPORT

International Application No

PCT/US 99/22020

A. CLASSIFICATION OF SUBJECT MATTER
IPC 7 G06F17/60

According to International Patent Classification (IPC) or to both national classification and IPC

B. FIELDS SEARCHED

Minimum documentation searched (classification system followed by classification symbols)

IPC 7 G06F

Documentation searched other than minimum documentation to the extent that such documents are included in the fields searched

Electronic data base consulted during the international search (name of data base and, where practical, search terms used)

C. DOCUMENTS CONSIDERED TO BE RELEVANT

| Category* | Citation of document, with indication, where appropriate, of the relevant passages | Relevant to claim No. |
|-----------|---|-----------------------|
| X | BAEHRING T U ET AL: "Using the World Wide Web--a new approach to risk identification of diabetes mellitus" INTERNATIONAL JOURNAL OF MEDICAL INFORMATICS, IR, ELSEVIER SCIENTIFIC PUBLISHERS, SHANNON, vol. 46, no. 1, 1 August 1997 (1997-08-01), pages 31-39, XP004085528 ISSN: 1386-5056 | 1,3-6 |
| Y | page 34, column 2, line 1 -page 35, column 1, line 12 | 2 |
| Y | US 5 752 236 A (SEXTON FRANK M ET AL) 12 May 1998 (1998-05-12) column 4, line 18 -column 6, line 19 -/-- | 2,7-12 |

Further documents are listed in the continuation of box C.

Patent family members are listed in annex.

* Special categories of cited documents:

- "A" document defining the general state of the art which is not considered to be of particular relevance
- "E" earlier document but published on or after the international filing date
- "L" document which may throw doubts on priority claim(s) or which is cited to establish the publication date of another citation or other special reason (as specified)
- "O" document referring to an oral disclosure, use, exhibition or other means
- "P" document published prior to the international filing date but later than the priority date claimed

- "T" later document published after the international filing date or priority date and not in conflict with the application but cited to understand the principle or theory underlying the invention
- "X" document of particular relevance; the claimed invention cannot be considered novel or cannot be considered to involve an inventive step when the document is taken alone
- "Y" document of particular relevance; the claimed invention cannot be considered to involve an inventive step when the document is combined with one or more other such documents, such combination being obvious to a person skilled in the art.
- "&" document member of the same patent family

Date of the actual completion of the international search

15 February 2000

Date of mailing of the international search report

25/02/2000

Name and mailing address of the ISA

European Patent Office, P.B. 5818 Patentlaan 2
NL - 2280 HV Rijswijk
Tel. (+31-70) 340-2040, Tx. 31 651 epo nl,
Fax: (+31-70) 340-3016

Authorized officer

Pedersen, N

INTERNATIONAL SEARCH REPORT

International Application No
PCT/US 99/22020

| C.(Continuation) DOCUMENTS CONSIDERED TO BE RELEVANT | | |
|--|---|-----------------------|
| Category | Citation of document, with indication, where appropriate, of the relevant passages | Relevant to claim No. |
| Y | EP 0 700 009 A (MINGUIJON PEREZ SALVADOR) 6 March 1996 (1996-03-06) column 1, line 55 -column 2, line 54 | 7-12 |
| X | PALFREY T R ET AL: "Repeated insurance contracts and learning" RAND JOURNAL OF ECONOMICS, AUTUMN 1985, USA, vol. 16, no. 3, pages 356-367, XP000878736 ISSN: 0741-6261 page 356, line 17 -page 357, line 6 | 1,3 |
| A | CLEMONS E K ET AL: "Information technology and information asymmetry: the future of private individual health insurance" PROCEEDINGS OF THE THIRTIETH HAWAII INTERNATIONAL CONFERENCE ON SYSTEM SCIENCES (CAT. NO.97TB100234), PROCEEDINGS OF THE THIRTIETH HAWAII INTERNATIONAL CONFERENCE ON SYSTEM SCIENCES, WAILEA, HI, USA, 7-10 JAN. 1997, pages 240-248 vol.3, XP002130528 1997, Los Alamitos, CA, USA, IEEE Comput. Soc. Press, USA ISBN: 0-8186-7743-0 page 240, column 2, line 40 -page 241, column 1, line 27 page 242, column 1, line 9 - line 27 | 1-12 |
| A | GB 2 231 420 A (AGENCY MANAGEMENT SERVICES INC) 14 November 1990 (1990-11-14) page 8, line 18 -page 9, line 5 | 1-12 |

1

INTERNATIONAL SEARCH REPORT

Information on patent family members

International Applica. No.

PCT/US 99/22020

| Patent document cited in search report | Publication date | Patent family member(s) | Publication date |
|---|---------------------|----------------------------|---------------------|
| US 5752236 A | 12-05-1998 | NONE | |
| EP 0700009 A | 06-03-1996 | ES 2108613 A | 16-12-1997 |
| GB 2231420 A | 14-11-1990 | NONE | |

BLANK PAGE